

[Anno]
2020

ARMETTA OFFICE

CATALOGO SICUREZZA

ANTONINO ARMETTA ARREDAMENTI UFFICIO

1. SCHERMI DI PROTEZIONE



ZEN PROTEC COS'E'

A cosa serve

Zen protec ti protegge da eventuali droplets rilasciati durante una normale conversazione.

Come è fatto

Un pannello in PMMA trasparente in varie misure sostenuto da supporti a morsetto o appoggio.

Sanificabile

Il PMMA può essere pulito con soluzioni a base alcolica di ogni tipo.

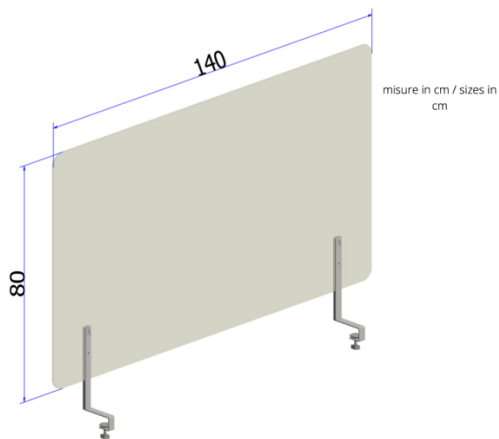

pannello con morsetti da aggancio sospeso dal top per facilitare il passaggio dei documenti /

Panel with clamps suspended from top to facilitate document sharing passage





uso frontale / frontal panel

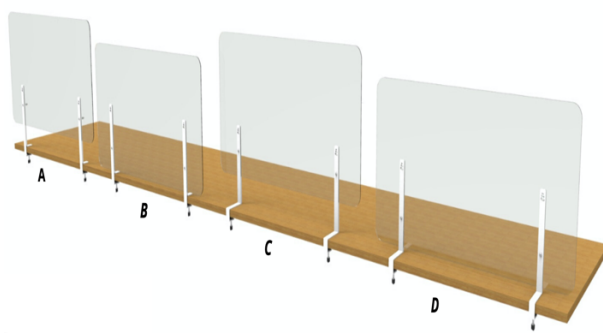
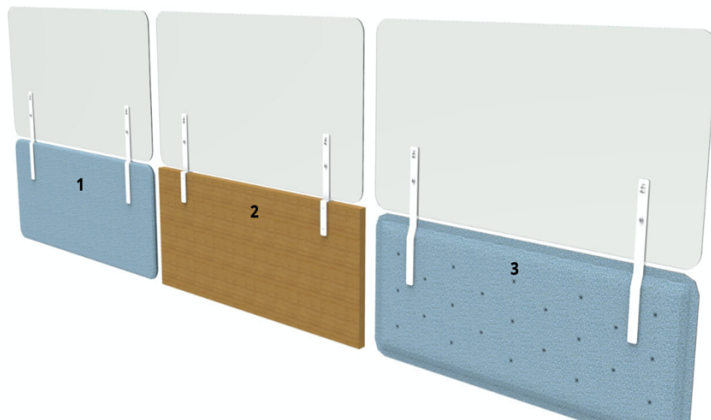

supporti disponibili / available supports



supporti per pannelli per passaggio carta / supports for panels document sharing passage

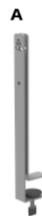

supporti per pannelli fino al piano / supports for panel from desktop



supporto per integrazione su pannello melaminico 18/30mm / fork for integration on mfc panel 18/30 mm



supporto per integrazione su pannello imbottito LAS SP.38 (10+18+10MM) / fork for integration upholstered panel LAS SP 38 (10+18+10 MM)



supporto per integrazione su pannello acustico zen / fork for integration on zen panel



2. PARETINE DIVISORIE PURIFICA ARIA

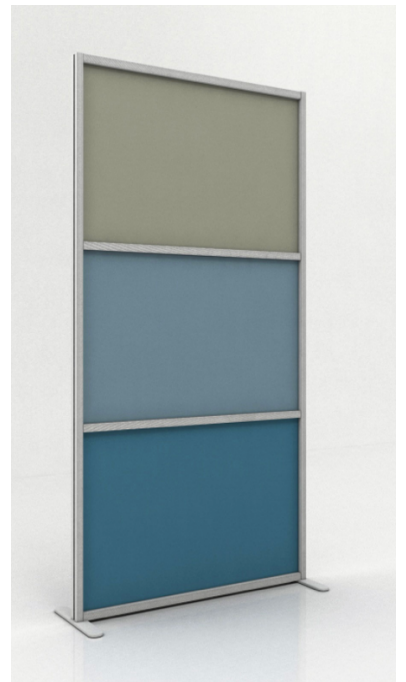



La prima paretina divisoria antibatterica attiva e ionizzante.

Ecoline purifica l'aria, igienizza gli ambienti e combatte gli odori indesiderati in modo perenne, **24 ore su 24, senza consumare energia.**

La sua straordinaria particolarità è di essere attiva sia alla luce che al buio.

Certificazione:

- antibatterica attiva ISO 22196:2001;
- ionizzazione ambientale rilasciata da NCT- Laboratori New Chemical Tecnology.



3. PARETINE DIVISORIE E FONOASSORBENTI



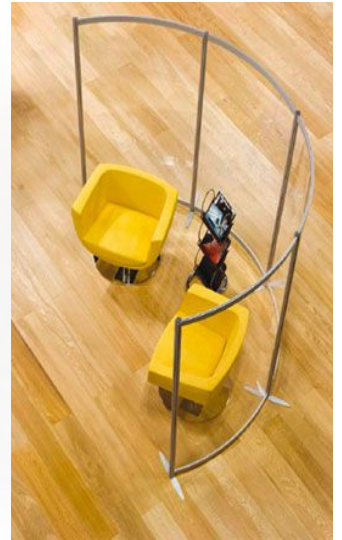

4. SCHERMI PROTEZIONE





VERSIONE APPOGGIATO
SUL PIANO

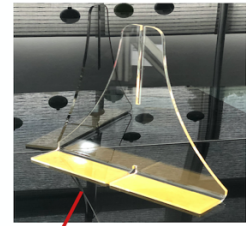

ACCESSORIO PER VERSIONE SCHERMO BLOCCATO
CON PIEDI INCOLLATI SUL PIANO CON NASTRO
BIADESIVO TRASPARENTE*

* LA STRISCIA GIALLA E' LA PROTEZIONE DEL NASTRO BIADESIVO

5. SOLUZIONI PER RISTORANTI



6. ADEVISI SICUREZZA



7. INDICAZIONI DI SICUREZZA



8. PIANTANA IGIENIZZANTE MANI



PIANTANA DISPENSER PER GEL DISINFETTANTE AUTOMATICO

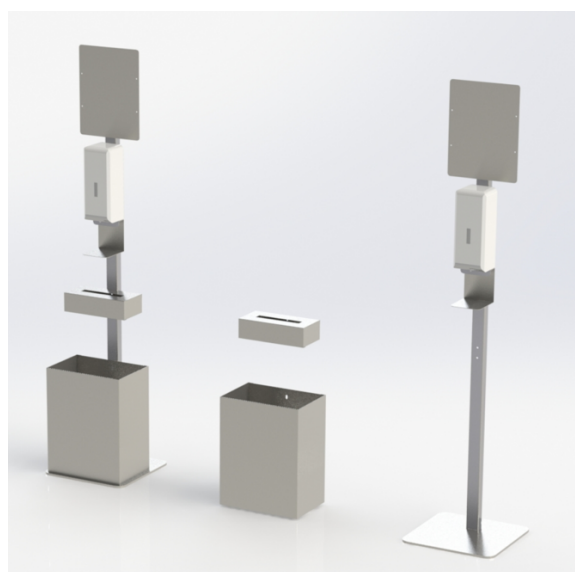

9. RICARICA 5LT GEL IGIENIZZANTE PER DISPENSER



10. DEPURATORE ARIA UFFICIO

